



HOBSONVILLE POINT



Design Guidelines

Catalina Sub Precinct, Hobsonville Point

July 2013

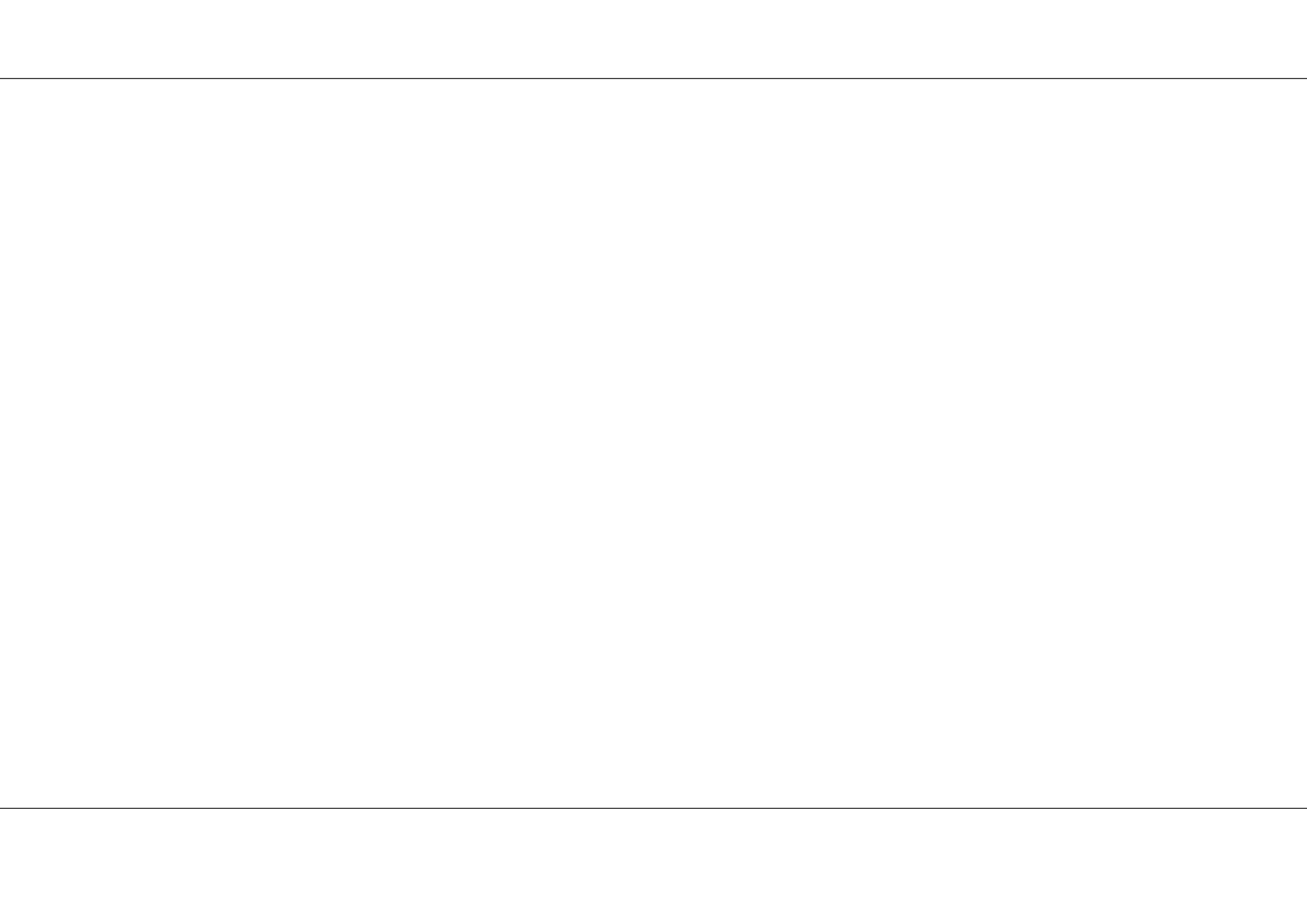



1

CATALINA SUB PRECINCT DESIGN GUIDELINES

1.1.1 INTRODUCTION TO DESIGN GUIDELINES

Purpose

- Retain and/or enhance existing features, including Notable buildings and spaces of heritage value.
- Ensure new development is of a coordinated, high quality that interacts positively with the public realm.
- Make provision for a choice of living environments, (including affordable typologies) commercial, social and community facilities and employment opportunities.
- Achieve a high standard of pedestrian amenity through design.
- Pursue principles of urban sustainability and excellence of urban form, including the maintenance of amenity values.

The Design Guidelines articulate the development vision for the Catalina Precinct, and prompt a considered design response to all subsequent development. They explain the character and standard of the detailed design that is expected of individual buildings and landscapes, while allowing flexibility and innovation.

Application of Design Guidelines

The assessment criteria for the construction of dwellings require consideration against the guidelines. In recognition that competing drivers can result in some specific design matters in these guidelines being achieved better than others, the assessment criteria requires an overall judgement as to whether an appropriate design outcome is achieved.

Objectives of the Design Guidelines

The overall objective is to provide a guide for developers and design consultants on design matters to be considered in the development of housing designs and as guidance for the Council's (or delegates) assessment of any application submitted.

The guidelines provide for the development of a specific Hobsonville Point character.

Document Structure

The Design Guidelines are structured in five parts as follows:

1. Introduction
2. Overall Design Approach
3. Architecture
4. Landscape
5. Heritage

1.2 OVERALL DESIGN APPROACH

1.2.1 HOBSONVILLE POINT DESIGN VALUES

Hobsonville Point will become a vibrant, relatively densely populated coastal settlement, bounded by the upper Waitemata Harbour. The architecture and landscape of all developments should celebrate the special qualities of the peninsula, which include access to the coastal edge and deep water, outlook over the harbour, and features which reveal its historical use as an airbase.

The casual, friendly characteristics of a coastal settlement are interpreted through integrated yet distinctive neighbourhoods, and a quality design approach that caters for lifestyle rather than just style. It calls for an expression of relaxed outdoor living through design values that are associated with a coastal village, including:

| | |
|----------------------|--|
| Directness | honesty and authenticity expressed in contemporary building styles |
| Openness | a relaxed relationship between buildings and open space |
| Lightness | the appearance of lightness rather than massiveness in building form and materials |
| Informality | the impression of a relaxed, open plan living style |
| Variety | individuality, complexity and richness created within each building, street or neighbourhood |
| Connectedness | making linkages to and around the coastal edge with streets and parks |
| Greenness | an overall impression of greenness, reinforcing coherence within the street |
| Setting | responsiveness to context and topography |

1.2.2 HOBSONVILLE POINT BUILT ENVIRONMENT CHARACTERISTICS

These characteristics apply equally to the character and quality of both the architecture and landscape of Hobsonville Point.

Design for Community

The value of community is implicit in the design characteristics intended for the coastal settlement of Hobsonville Point. In this context, community relates particularly to matters of urban form and responsibility to the public realm.

The application of best practice urban design principles will ensure that buildings are good neighbours to one another, and contribute to safe, integrated living environments with a sense of identity and community. For architecture, this includes the way in which buildings address the street or an adjoining open space, and their contribution to the quality of the public realm through detailing and variation in form. For landscape, it includes the consistency and legibility of the public realm that contributes to the character of a place.

Distinctive urban design elements are required to define neighbourhoods, assist with orientation and reinforce the character of Hobsonville Point. Buildings that define key streets, corners and intersections have a particularly important role to play in this.

Openness, lightness and outdoor living are attributes that are appropriate to a coastal settlement and the Kiwi way of living. To achieve openness, the demarcation between public and private must be clear, with defined edges between private and public space.

A textured and defined interface at the street edge allows for an extension of living space, while still maintaining surveillance and outlook to the street. Front yards overlook the street and contribute to a sense of community and being neighbourly.

A wide range of housing prices is encouraged for the area, from quality, simple, small and affordable homes to large high value homes.

Design for Living

The expression of a casual and relaxed outdoor living style is intrinsic to Hobsonville. This means creating functional features that allow open plan living, such as verandahs and terraces, and functional entrances and front yards that are open and welcoming. Attention to sustainable design requirements will give an overall impression of directness, usefulness and authenticity. These considerations cater for lifestyle, rather than just 'style'.

A feeling of space rather than crowding can be created by orientation of the house on the lot to minimise overlooking, and to provide outlook to borrowed views and public space.

Design for Quality

A combination of visual richness and coherence is created by an appropriate architectural language and composition, construction systems, materials, finishes, colour and detail that together provides a sense of quality.

Architectural elements should be honest, direct, functional and an integrated part of the built form. Combinations of materials and their careful application are important to create rich textures and contrast. Individuality and personalisation are encouraged.

Therefore, with the exception of some excluded materials that do not meet requirements for quality and longevity, the Design Guide will primarily control the application of materials to achieve quality detailing. Materials should be used in a way that reveals their integrity and permanence, with current technology and sustainable design principles informing material choice and performance.

1.3 ARCHITECTURE

1.3.1 ARCHITECTURAL VALUES

The following architectural values are regarded as distinctive and appropriate to the Hobsonville neighbourhood. They are to be achieved by all buildings and peripheral elements whether they front onto streets, parks, or rear lanes.

Directness

Directness is expressed in the way building components are selected and put together. Architecture should be contemporary in style, technology and materials, except in special cases to be agreed. Historicist reconstructions and fake facades are not appropriate. Buildings and groups of buildings should be visually coherent.

Openness

Openness is expressed in the relationship of buildings to private open space, to streets, to parks and to the larger context. An easy and relaxed relationship is appropriate. This affects the architectural gestures which building forms make, and the architectural vocabulary used.

Appropriate examples include:

- open gable roof forms addressing the street
- cantilevered roofs and floors
- prominent balconies and verandahs
- strong modelling of walls
- emphasising solid and void, as in recessed doorways
- added pergolas, awnings, window boxes
- openable windows and doors (natural ventilation preferred over air conditioning)
- emphasis on passive ventilation as part of an over-all environmental performance strategy for Hobsonville.

Lightness

Lightness is expressed in structure and material, physically and visually. Generally, an appearance of lightness rather than massiveness is favoured. This does not exclude the possibility of a structure which appears to float over a solid base, or other cases in which lightness is intensified by contrast with solidity.

Examples include:

- roofs which visually 'float' above walls.
- framed structures with panel infill.
- use of glass to separate and visually lighten more solid elements.

Informality

Informality is expressed through a relaxed architectural manner rather than a formal one. Incorporation of mock-formal architectural statements, such as Greek porticos on applied columns for example, is not appropriate.

Variety

Variety is expressed in form, colour and material. Individual buildings require the considered and coherent use of material and colour, but with a higher degree of variety than is usual in most housing developments. Generally, crisp contrasts in colour will help achieve the required sense of lightness and openness, and will more successfully evoke seafront associations than sombre colours of similar hue.

Setting

Setting is honoured through the form, colour, material and positioning of a building on the lot and how it addresses its frontages. As with 'openness' it is expressed through the relationship of the building to the street and any adjacent public open space. Further to this, the design of a building should carefully consider the topography of the site, the neighbouring dwellings (which may or may not be built at the time), views and sunlight, along with proximity to and association with buildings and spaces of heritage value.

1.3.2 DESIGN FOR COMMUNITY

Facade diversity

Facades are described as the street frontage or frontages of any building. Facades should be designed to:

- create a diverse, interesting street appearance,
- avoid excessive building mass,
- include variation in the use of materials.
- provide a strong and coherent human scale street frontage

Facade composition and scale

Facade composition includes the arrangement of windows, doors and architectural detailing to provide variety and rhythm to a facade.

The design of facades should emphasise the width of individual residential units. For example, where a building contains more than one unit the facade should be designed to articulate the individual units and in this way break the facade into smaller vertical elements.

Building scale and hierarchy

The principal facade of a commercial or mixed use building should be articulated in a way that visually diminishes the overall bulk of the building, and provides balanced proportion and scale relative to height.

Roofscape

The roofscape is described as the part of the building above the eave or projected ceiling line of any building

- Buildings should be designed to provide a varied roofline.
- The profile of the roofline against the sky should have interest and variety.
- The construction of attic spaces and useful roof space is to be encouraged and should be visually apparent through windows and roof vents.

Building line variation

Buildings will be sited to a building line determined by front setbacks. Building line variation is defined as the portion of the building form that must be separated from the primary frontage on the building line.

Some secondary elements may extend beyond the building line, including:

Chimneys, bay windows, balconies, entrance canopies, sun shade devices, louvres, eave depths up to 600mm, rainwater goods (gutters, downpipes, rainwater heads).



Facade diversity



Facade composition and scale



Roofscape



Building line variation

1.3 ARCHITECTURE

1.3.2 DESIGN FOR COMMUNITY continued.

Buildings at T-Road intersections

Buildings at important intersections should provide some special architecture features to take advantage of the terminating vistas at these alignment points.

Rear and side elevation treatments

Special architectural attention should be given to the side and rear elevations of buildings that are visible from streets, parks, institutional sites, open spaces, public walkways and commercial blocks. The architectural treatments of these elevations should maintain the same quality as the front elevation in respect of materiality, placement of windows and other architectural elements.

Buildings fronting open spaces and pedestrian walkways

Buildings fronting an open space or walkway should be regarded as an occupied frontage and should be treated in the same way as buildings which directly address the street. There should be no 1.8m privacy fencing to park frontages, and the building frontage should be kept as open as possible to provide good informal surveillance. Refer to Coastal Edge and Public Open Space Fencing in the Landscape section for fence heights.

Upper Level Setback

In some cases it may be appropriate to set back upper levels, on a building over 4 stories, from the building facade. A recommended upper level setback is 3m. Secondary architectural elements such as balconies, cornices or other detail protrusions within the set back may be deemed appropriate in the context of the buildings overall design and shall be subject to consideration by the Design Review Panel.

The intention of the upper level setback is to maintain a human scale building frontage without restricting the overall height and consequent intensity and land value.



Buildings at T-Road intersections



Rear and side elevation treatments

Marker buildings

Marker buildings should be located at key street junctions where sightlines down a street terminate or change direction creating a focus of view, they should also be located at key positions on the coastal edge and on the edge of heritage open space. The Catalina Precinct should contain a hierarchy of Marker Buildings, based on their location, bulk and form.

A marker building is a complete building design that sets itself apart from its surroundings. It can be achieved through a stronger articulation of existing context or the development of a new form. In all cases, the architectural form should be clear and coherent, the building may increase in scale and the public and private interface is critical.

Marker buildings play an important role in a community:

- They provide a natural reference point to act as an organiser for one's mental map of the area;
- They have the potential to be functionally different (all or in part) from a more general surrounding function;
- They have the ability to heighten a sense of connection and community for the inhabitants of the area;
- They have the ability to shape and organise adjacent buildings and public open space.

A marker building should therefore receive added prominence by:

- Being "obvious" in its makeup and placement within the spatial framework;
- Being able to accommodate activities other than, or in addition to, nearby largely residential occupancy;

- Evoking a distinctive, high quality and well-articulated building form;
- Demonstrating a clear appreciation of the urban context unique to its setting

All marker buildings should have regard for their specific location and should be designed to:

- display added prominence through their building form and/or height and to enhance existing site qualities.
- ensure that ground floors have additional ceiling height;
- achieve a positive interface with the adjacent public realm;
- be architecturally superior through high quality design and detailing;
- be skillfully integrated into its setting by careful consideration of the space around.

It may also be appropriate for marker buildings to exceed the standard specified building heights.

The maximum floor to ceiling height for an additional floor in a marker building should not exceed 3.5m.

Three general location categories for marker buildings have been identified:

Where a marker building occurs on the coastal edge, it should be considered as a focal point within a significant natural surrounding landscape. It should have an obvious "object-in-the-landscape" design approach and should benefit from space or run-up surrounding the building.

Where a marker building is a new building close to identified heritage features it should demonstrate a sympathetic response to such buildings or spaces. It should have regard to scale, proportion and setting, but should employ a contemporary design approach to materials and detailing to compliment identified heritage and architectural values.

A marker building occurring at a junction should address and activate all its street frontages and should observe the minimum allowable setback. The design of the building should acknowledge the significance of the corner location and it may have a minimum additional height (all or in part) of 1.5m above the roof line of adjacent buildings.



1.3 ARCHITECTURE

1.3.2 DESIGN FOR COMMUNITY continued.

Corner lot treatment

Buildings on corner lots should be designed to address both street frontages. These buildings should have some special architectural features to reinforce the corner. Impermeable privacy fencing of these lots should only be used to screen rear yards.

Rear lots

Hobsonville Point is masterplanned to provide street and lane based housing. "Jointly owned access lots" or "Rights of Way" created for the access to individual or small groups of rear lot housing are to be discouraged. All attempts should be made in the masterplanning of the final roading and lot layout design to discourage these forms of development and create street fronted lots.

Block sizes

Perimeter blocks should be modestly sized in order to preserve permeability and the creation of walkable neighbourhoods.

Street frontage

Street frontage is described as being the parts of a building that are specifically designed to overlook the street and thereby create a positive frontage. As a minimum street frontages should include windows from a habitable room, e.g. lounge or kitchen, overlooking the street. On corner sites the front door access should face the street with the highest priority. In situations where the two intersecting streets have the same priority (such as two local / minor streets), the main entry may directly face the corner or either of the two street frontages, but the approach should be varied for each corner lot. The building form and architectural detailing of street frontages should be articulated to clearly define entrances.

Group Carparking

Off street group car parking areas may be associated with apartments, retail activities, schools and other similar land use activities. The following design principles relate to both public and private group car parking:

- A positive frontage should be presented to the street with high quality boundary landscaping treatment such as permeable fencing and hedge planting less than 1.5m in height to screen cars but allow for passive surveillance from the street
- Adequate space for landscaping should be provided, including a recommended 1 medium scale tree and groundcover planting for every 3 car park spaces where carparks occur in a single row, or every 6 car park spaces where carparks occur in a double row, back to back.
- Shared surfaces may be used to indicate equal status for vehicles and pedestrians, footpaths may not be required
- Vehicle speeds may be reduced through the use of landscaping and tree planting for enclosure. Changes in surface material that differentiate parking bays from manoeuvring aisles will also assist.
- Lighting should be provided for security
- Permeable surface materials and Low Impact Design [LID] treatment should be used where possible
- Adjacent buildings should be designed with an active frontage to car park areas
- If physical speed restrictions are required these can include vertical displacement e.g. raised tables and horizontal displacement e.g. narrowing at entry and exit points



Corner lot treatment



Street frontage

Marine Industry Precinct Interface

The Marine Industry Precinct (MIP) has southern and western boundaries adjacent the Residential zoned land of the Catalina Precinct.

This interface requires careful consideration because of the dissimilar land use and building typologies adjacent to one another. The Catalina Precinct edge presents a residential frontage that can range between 1 and 3 floors, depending on building typology. That equates to a height range of between 4 - 10.5m (as seen from the street), 1-3 storeys lower than the MIP edge which has a height range of between 12 and 15m proximate to the street boundary.

The residential frontage on the south edge has a northerly aspect onto the MIP which presents issues of sensitivity to some extent in that primary living spaces and balconies are likely to face the MIP to achieve solar gain. Street activation, screening and overlooking must therefore be carefully considered in that these face onto a predominantly marine shed and carparking frontage. The aspect of the buildings fronting the western edge of the MIP is such that private open space could be located away from the MIP interface, however street activation through positive frontage will still be important.

There is however, a landscape buffer proposed along the boundaries which should go some way to mitigate these issues.

Outcomes sought for MIP interface streets:

- Buildings that are at the upper end of the height scale for the zone so as to give a strong and balanced edge condition to both sides of the street and provide as much screening of the MIP sheds from the surrounding area as possible.
- Buildings that offer visual interest and richness of materials, textures and colours as a counterbalance to the marine sheds.
- Buildings that offer good levels of surveillance from balconies and living spaces.

Bomb Point Interface

It is important that apartments at the eastern end of Catalina have a positive relationship with the Bomb Point landscape.

Buildings are best orientated in an east west alignment to maximise views from and between them. Taller buildings should be located in the centre along the parkway character street. This helps to frame views out to Bomb Point and the harbour, creating a sense of approach and arrival for visitors, as well as maximising opportunity for views from the upper floor apartments over potential surrounding buildings.

Facades of apartment buildings adjacent Bomb Point should incorporate shadow, change of material and other architectural treatments that enable the buildings to feel finely grained and textural in their appearance. This 'grain' should be at a scale complimentary to the individual buildings and bunkers on Bomb Point. Apartment buildings should give the impression they are made up of many individual units, any feeling of excessive building mass is to be avoided.

Apartments at street level should have their own private access off the street, apartments above may share an access lobby and/or elevator well, or be accessible by individual 'walk up' entrances.

1.3 ARCHITECTURE

1.3.3 DESIGN FOR LIVING

GENERAL

Architectural character will in part be determined by functional requirements of the housing types described in this document, rather than by exterior styles. An example is the relation of house units to private open spaces, and to the street or other public space. Another is making the best use of the sun's energy through passive solar design. Following are specific requirements affecting form and the appearance of buildings, in context:

Environmental response

Good environmentally responsive design will generate –

- Creative architectural forms, which are functional and useful.
- Economic viability for the duration of Hobsonville.
- Comfortable light and energy efficient homes through the application of passive solar design principles.
- Reduced environmental impact and running costs through energy and water efficiency and the use of environmentally preferable materials.

Examples - orientation of living spaces to the north, the use of eaves and other external shading structures to avoid overheating, good insulation and applied mechanisms such as water tanks and solar collectors.

Private open space

Demarcations apply to front yards and between adjoining private open spaces at ground level. Visual separations should be constructed between adjoining balconies or terraces to separate upper level houses or apartments.

Private open spaces should be directly accessible from main living areas, and whether at ground floor or at upper levels (balconies and verandahs), should be proportioned to comfortably accommodate outdoor living functions.

Outdoor living areas should be partly covered for shade and rain protection, preferably from the access doors outward.



Environmental response



Private open space



Solar access to private open space

Explanation

Buildings should not significantly overshadow private open spaces (including neighbouring private open spaces) or significantly obstruct daylight into habitable room windows of adjacent buildings. Buildings should be designed to allow private open spaces to receive at least 3 hours of sunlight on June 21st for at least 50% of the private open space area, or 5 hours on 21st September for at least 50% of the private open space area. This should be demonstrated by shadow diagrams that include neighbouring sites. Private open space should not be located in the south east / south west quadrant of a site.

Shadow diagrams

Shadow diagrams should be used to illustrate the shadows cast on private open spaces by the proposed buildings at hourly intervals.

Shadow diagrams are to be provided for the site and neighbouring sites and are to include the following information:

- Extent of building bulk
- Location and extent of private open spaces
- Area or percentage of private open space that receives direct sunlight at hourly intervals

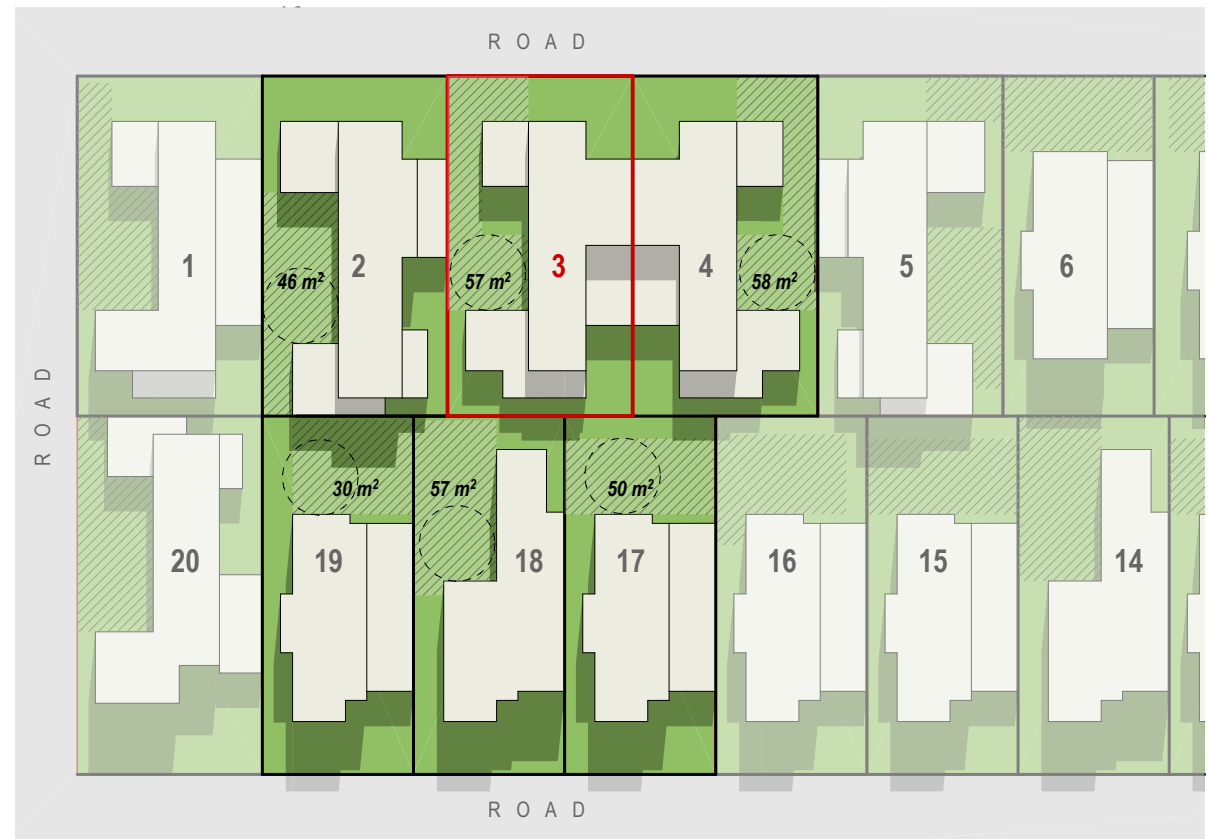

Legend

- Building bulk
- Private open space
- Extent of private open space in shadow
- Extent of private open space receiving sunlight

SHADOW DIAGRAM SUMMARY - 21 SEPTEMBER 12pm

| | Unit 2 | Unit 3 | Unit 4 | Unit 17 | Unit 18 | Unit 19 |
|-------------|------------------|------------------|------------------|------------------|------------------|------------------|
| POS area | 60m ² | 60m ² | 60m ² | 50m ² | 60m ² | 50m ² |
| Area in sun | 46m ² | 57m ² | 58m ² | 50m ² | 57m ² | 30m ² |
| >50% in sun | ✓ | ✓ | ✓ | ✓ | ✓ | ✓ |

1.3 ARCHITECTURE

1.3.3 DESIGN FOR LIVING continued.

Building entrances

Entrances to houses or housing should be protected from rain, and preferably recessed from the general wall plane. They should be sited so they are not compromised by pedestrian and vehicular traffic.

Garages and car parking

Minimising the visual impact of car parking and garage doors is a priority, particularly at street frontages.

Heat gain and loss

Windows and doors should be sized and positioned to control excessive heat gain and loss, and external shading provided to assist this where appropriate. This should reduce dependence on the need for internal control of solar heat gain (e.g. by curtains or blinds).

Natural ventilation

All habitable rooms should be naturally ventilated with opening windows and/or doors or vents. Cross-ventilation is highly desirable. A proportion of windows must be able to be left open without compromising security to allow for cross ventilation. This can be achieved through high level windows or security stays.

Artificial ventilation or air-conditioning is not encouraged.

Service areas

Service areas for rubbish bins, clotheslines and garden storage should be sited in rear or side yards, so as not to compromise private outdoor space or be visually obtrusive. Clotheslines should be linear and retractable or fold away. Care must be taken to ensure areas are large enough for wheelie bins for rubbish, recycling and garden rubbish. Bins should be able to be stored out of the rain, and out of the view of the public when seen from the street.

Waste-water plumbing, drainage pipework and other services ducting should generally be concealed from view from the street.

Rain-water pipes and tanks should be as unobtrusive as possible, and down-pipes run with minimum bends. A mid-range neutral paint colour is appropriate. Unpainted upvc is unacceptable.



Heat gain and loss



Natural ventilation

Television and radio antennae. The development will be providing fibre for triple play services (internet, telephone and television) to every building. This should ensure that there is no need for external antennae. Dwellings should be wired to supply at least one data point per level. If antennae are installed they should not be visible from the street. They should be mounted in a way which does not compromise the weatherproofness of the roof (i.e. with flashed brackets, or with raised pads in low-pitch membrane roofs).

Heat Pumps pool pumps, and other mechanical plant should be sited out of public view, and positioned to minimise noise nuisance to neighbours.

Water Tanks and associated pipework should be unobtrusive. Tanks may only be sited in front yards if they are underground.

Signs should fit their architectural context, and the total area of all signs should be no greater than 0.10 square meters for any home occupation or 0.25 square metres for any other premise.

Outlook and Privacy

Designs should encourage an attractive interface between public and private realms that facilitates outlook and social interaction whilst balancing the need for privacy.

Care must be taken to provide privacy for occupants, particularly when the separation distance between windows is less than 6m. In general, directly facing windows should be avoided where the separation distance is less than or equal to 6m. Any sense of being observed while going about one's daily life in the house or apartment must be minimised. This applies to being overlooked from both the street and adjacent dwellings.

Direct views into adjacent private open spaces and habitable room windows of adjacent dwellings should be avoided. If a private open space area cannot deliver an appropriate level of visual privacy for occupants (e.g. the space is on the street frontage and is overlooked) a secondary secluded private space area may be required for that dwelling.

Windows should be located and sized to provide outlook and also offer appropriate visual privacy using a combination of:

- screening, including curtains and blinds
- planting
- separation distance
- offset windows a min of 1m
- have sill heights above 1.6m
- have fixed obscure glazing in any part of the window below 1.6m or:
- be behind a fence if on the ground floor.



Overlooking



1.3 ARCHITECTURE

1.3.3 DESIGN FOR LIVING continued.

Lanes

Rear access lanes provide access to garages and parking spaces at the rear of properties. They are typically associated with attached housing and some apartment style housing. Whilst their primary function is one of access, they also play an important communal role as “shared” community spaces for the participating residents, and are part of a wider network of connections for the local community.

To ensure a good design outcome for rear lanes, the following design principles are proposed:

- Gateway buildings should be provided at the entrance point to rear lanes, to overlook the laneway. These may take the form of individual buildings or loft apartments over garages [not a separate dwelling].
- Shared surfaces should be used to indicate equal status for vehicles and pedestrians, so that footpaths will not be required.
- Garage setbacks should be varied to provide variety to the streetscape, and trees, shrubs and surfaces will add visual interest.

- Opportunities for the provision of lofts over garage units (in addition to gateway buildings) are encouraged to improve surveillance.
- Semi-transparent fencing may be used in rear lanes to provide privacy with a degree of overlooking of lanes.
- Adequate space for quality landscaping should be provided.
- Gateways to properties should be provided within the rear fence and the garage unit.
- Lighting should be provided along lanes.
- Vehicle speed will be lowered through reduced carriageway widths and block lengths, and the use of tree planting and building height to create enclosure.
- If physical speed restrictions are required, these can include vertical displacement - eg speed tables, horizontal displacement, chicanes and road narrowing, and permitting on-street parking in combination with narrower roads.
- All rear lane accesses should provide a continuous connection through their respective blocks to ensure permeability, and to allow rubbish truck access for refuse collection from individual homes.

Since rear lanes perform several functions, accommodating pedestrians as well as vehicles, it is important that they are pleasant places to be in. For this reason a number of architectural devices are appropriate to enliven lanes and improve safety:

- A pleasing mix of garage doors is desirable in conjunction with gateways, fences, and trees.
- No more than two adjoining double garage doors should be located without some intervening break.
- The material and patterning of garage doors should be designed to reduce their blandness and bulk.
- Verandahs or balconies serving accommodation built over garages should be used to increase surveillance of lanes, and add formal variety to the public space.
- Careful attention should be given to the size, setback and detailing of gates to allow good pedestrian access combined with ease of access for items such as wheelie-bins.
- The practical and aesthetic standards which apply to buildings and fences in general, apply also to lane frontages.



Lanes

Homezones

A homezone is a communal lane which provides for the gathering of residents and a safe play area for children. The physical layout and design of the homezone will encourage reduced vehicle speeds to 20 kph and below, without the need for signage or road markings.

Homezones and shared surface streets are part of the public realm and will be designed and approved at the superlot subdivision stage. There will need to be a review of these types of streets at the time the adjoining lot development is designed. This may require some changes made to the original street designs prior to construction. It will be critical that the Council or its delegate review the Homezones and shared surface street designs when the adjoining lot development is detailed to ensure integrated design is achieved between the street and the adjoining buildings.

Unlike lanes, homezones will function as the front address for some, if not all, of the units located on them.

They should be designed in accordance with the principles related to lanes, and in addition to these, homezones also require careful consideration of the following:

- Letterboxes should be incorporated where the homezone is the unit's front address.
- Street elements should be used to create a more accentuated horizontal shift in vehicle paths, helping to reduce traffic speeds.
- Gateway treatments at entrances to homezones set the tone and character for each zone and should include feature planting along with more prominent architectural form.

- Ensure entrances to units are clearly articulated, not compromised by pedestrian or vehicular traffic and suitably sheltered to function as the building's front door, especially where the homezone operates as the unit's front address.
- Buildings should be designed to ensure positive street frontage and overlooking to the homezone.



1.3 ARCHITECTURE

1.3.3 DESIGN FOR LIVING continued.

APARTMENTS

In addition to the Design for Living requirements relating to all housing typologies, there are some design requirements that apply specifically to apartments. Apartment style living requires an exceptional level of amenity based on a strategy of place-making. Proximity to services, schools, public transport, convenience shopping, open spaces and social infrastructure are fundamental considerations.

The following additional requirements for apartments affect form, function and appearance, and should be taken into consideration

Overshadowing

Environmentally responsive design should explore creative architectural forms that avoid overshadowing and optimise solar access for dwellings, both within the development and on neighbouring sites.

Ground level design

The ground level in all units is significant because it offers the potential for a different set of amenities to both the residents and the public realm over that of the upper levels. To maximise the opportunities of the ground level the following principles should be considered:

- Maximise the number of individual entrances at ground level in order to contribute to safe and active streets and provide visual interest to the public realm.
- Provide clear demarcation between private, semi public and public space, particularly at ground level.
- Provide outlook from living rooms fronting streets and open spaces while maintaining visual privacy for occupants by the use of appropriate fencing, landscape treatment and changes in level.
- Incorporate universal design principles (i.e. accessible for all).
- Avoid blank facades and ground floor parking beneath apartment buildings visible from the public and semi public realms.

Building Access

Access to apartment buildings should:

- ensure that buildings are accessible for all (including able bodied and mobility- or sensory-impaired people),
- create legibility and contribute to the street quality by ensuring entrances are integrated yet identifiable elements,
- ensure pedestrian entrances are well lit, highly visible, and sheltered from the elements,
- provide separate pedestrian and vehicular access for residential and other activities to ensure security and safety for all users and to animate the street, and
- minimise the number and width of vehicle entry/exit points in order to maximise the potential for active street frontages, and
- where possible, organise vehicle access points off side streets or lanes.



Ground level design



Building access



Communal open space

Communal open space should be considered in terms of the urban context and proximity of public open space. Communal spaces should be clearly defined from private and public open spaces. Trade-offs can be considered between the amount of communal and private open space.

The massing, location and orientation of apartment buildings should enhance the quality of communal open space areas. Communal open space should be located to optimise solar access to buildings and the open space, to minimise overshadowing and provide outlook from units. At the same time, such spaces should themselves have ample access to sunlight.

Visual and Acoustic Privacy:

Apartment units should be arranged within a development to minimise noise transmission between units, by:

- grouping noisy areas next to each other and away from quieter areas,
- locating storage or circulation zones to buffer noise from adjacent units, and
- minimising the quantity of inter-tenancy walls.

Visual privacy for apartments can be optimised without compromising view, outlook or ventilation. Visual privacy should be achieved between buildings both within the site and between neighbouring properties by:

- ensuring adequate building separation and setback internally,
- providing adequate separation between apartment windows and communal open space and through-site access routes,
- utilising changes in level between ground floor apartments and public space, and
- using building design elements such as: recessed balconies, vertical fins, screen panels, etc.

Above ground private open space

Balconies may be used to meet the provision for private open space in the upper levels of apartment buildings (i.e. all levels above the ground floor). However, alternative solutions are encouraged to provide variation and diversity, for of both outdoor living options and the visual appearance of the building. For example, some above ground private open space may be recessed back from the building facade, providing integrated solutions for shade and shelter.



Communal open space



Visual and acoustic privacy



Above ground private open space



1.3 ARCHITECTURE

1.3.3 DESIGN FOR LIVING continued.

SMALL HOUSES

In addition to the Design for Living requirements relating to all housing typologies, there are some design requirements that apply specifically to small houses. The intent is to create high quality, high amenity, small houses on small lots, arranged to create positive social dynamics including; active street frontage; sunny outdoor space with good indoor-outdoor flow; well integrated into the wider Hobsonville Point development.

Living Amenity – Indoor-Outdoor Flow

To ensure a high level of living amenity for small houses on small lots, principal internal living spaces should open directly to the allocated private outdoor space, with the private outdoor space located in a part of the site that receives good solar access.

To make the best use of the site it is recommended that the long side of the house is positioned on the zero lot side boundary where possible, enabling the dwelling to be used as a fence.

Private Outdoor Space

Designs for small houses on small lots should take into account the location and arrangement of private outdoor space, and the elements within it to optimise visual and acoustic privacy between neighbouring properties. Visual and acoustic privacy can be optimised through careful consideration of the arrangement of fencing &/or planting &/or the grouping of external storage elements.

To encourage an active street frontage, soft landscape elements e.g. low level planting should be considered to demarcate the front boundary in lieu of fencing. Soft landscaping elements can also be used to demarcate rear and side lot boundaries & private outdoor space where privacy is not paramount, to facilitate a more shared approach to outdoor space.

Outdoor space may be located in the front yard where this makes good use of a sunny aspect.



Group Size & Variety

The group size and variety of small house typologies within a grouping is significant because it offers the potential for establishing a community of different household make-ups in close proximity, and enables a cohesive spatial group to be formed. Layouts should take into account an optimum amount of variety to avoid complete repetition in a group, and to avoid 'one of everything' creating lack of cohesion.

Limiting the group size will avoid the creation of 'precincts' of small houses. To limit the creation of 'precincts' a maximum of six small houses in a group is recommended.

Massing & Arrangement

The massing and arrangement of small houses is significant because it influences how the small houses can positively effect the quality of the overall development, create good urban form outcomes, and ensure good solar access and amenity to each house.

Small houses should be aligned to face the street or lane, taking into account how groupings of small houses 'turn corners' to enable both streets to be activated by building frontage.

It is important that designs take into account the mix, massing and arrangement of stand-alone, duplex, &/or terraced; single and two-storey houses in relation to surrounding built form context to:

- orientate small houses for good solar access;
- ensure good solar access to the individual lots;
- avoid overshadowing of neighbouring houses;
- avoid overbearing by neighbouring houses.
- provide consistency of streetscape appearance in terms of height, scale and rhythm of buildings.

Car Parking

Car parking for small houses can be provided on site by way of garage, carport or car pad. Regard should also be given to the potential for car parking to be provided in small groups nearby, as part of the overall site master plan, enabling the small houses to be moved forward on their individual lots to maximise solar access to private outdoor space.

When designing small houses developments, carparking can have the potential to have adverse visual effects on the streetscape. Careful design needs to be completed to ensure the building mass, entries to the house and carparking are fully integrated with the landscape treatment for the site and the streetscape. Limiting the number of carparks in a row, ensuring good landscape treatment to reduce visual impact and integrating with the existing street trees should all be encouraged to help avoid any adverse visual effects.

External Storage & Service Areas

It is recommended that external storage units, rain water tanks and clotheslines are grouped together where practicable, and located within the rear or side yard of the small house lot.

Designs should take into account opportunities where these elements can be arranged with neighbouring properties to help with privacy and fencing between lots.

A minimum of 6m³ of storage should be provided per small house lot. This may be provided externally or could also be provided internally, such as within a garage.

1.3 ARCHITECTURE

1.3.4 DESIGN FOR QUALITY

The visual richness and coherence of Hobsonville will be affected by a combination of architectural language and composition, construction system, materials, finishes, colour and detail. This applies equally to peripheral elements such as fences and letterboxes.

Coherence and variety

Care should be taken in the design of the architecture to reinforce the urban design intentions. The Design Guidelines for Catalina Precinct have been carefully formulated to ensure that built form contributes to the creation of street spaces and groups of buildings with specific qualities and differing scales. Each building should be designed with consideration for its setting within the group, so as to ensure a sense of overall coherence. Within each group, variety in detail and the use of materials will create an environment of richness without forced variety. It will not be appropriate to design different facades for adjacent buildings which are of the same form, where these occur in large numbers.

There will be occasions where coherence may be achieved by a single façade treatment which continues the length of a block on one or both sides of a street. In other cases, the facades may vary as they progress along the block. As with any city which has developed over generations, both will be acceptable as long as the other requirements listed in this Design Guide are incorporated. In all cases, the individuality of each unit or residence within the block should be expressed.

In many cases blocks will incorporate distinctive 'gems' in previously identified locations, such as corner sites. Here the architectural language may vary in accordance with the location and form.

The compositional possibilities for each site or block should be discussed by the designer/developer with the Design Panel before the design stage begins. Pre Design briefings by the Design Panel will assist with this process.

Construction systems

Buildings are to be constructed using contemporary systems and materials. Materials should be incorporated in such a way as to reinforce the expressive gestures of the building – for example: solid forms will suggest the use of solid materials, lighter more open forms will suggest visually lighter materials. Functional and sustainable detailing is expected, to ensure durability of the resulting building.

Materials

Materials should wherever possible express what they are, rather than attempting to represent another material. The intention is to maintain quality standards for the development. The extent to which certain materials are used, and manner in which they are detailed, should be thoroughly considered by the designers. Materials such as upvc weatherboarding, pressed metal roofing tiles, and fibre-cement products must be shown to be appropriate for the circumstances of their use, and may not be specified if the way in which they are to be used results in lowering the overall quality of the development. Certain materials and systems are excluded for aesthetic and/or practical reasons.

These are:

- Timber or steel framed wall constructions supporting monolithic plaster systems. (Plaster is acceptable on concrete and masonry, including brick veneer)
- Pre-rusted steel cladding panels as weatherproofing skins
- Expanded polystyrene panel systems covered with high build paint.
- Exposed tanalised pole retaining walls. (Visual impact to be mitigated by planting and or screening)
- Lead.
- Galvanised and zinc/aluminium-coated steel internal guttering
- Aggregate chip-coated waterproofing membranes to gutters
- Aggregate chip-coated roofing tiles
- Fibre cement fencing of any profile or sheet form
- Unpainted or unstained Pine timber walls, fencing, or ancillary structures

Combinations of colour, texture and materials to achieve variety and interest along a street and express a sense of place



1.4 LANDSCAPE



1.4.1 LANDSCAPE VALUES

The landscape values of connectedness, greenness and setting are regarded as distinctive and appropriate to the Hobsonville neighbourhood. These are to be achieved through the design of both the public, and private realms where these are visible from public spaces (i.e. the way that front yards interface with streets and open spaces should reinforce the character of the peninsula).

The design principles for the public realm are explained further under Design for Community and apply to:

- streets
- the coastal edge
- neighbourhood open space
- heritage landscapes

The design principles for the private realm are explained further under Design for Living and apply to:

- detached housing
- heritage buildings
- attached housing
- apartments and communal open space

The landscape values are reinforced through planting themes that define street and open space character areas; (Refer to Street and Lot Frontage Planting Themes Plan and associated explanation on the following page).

Connectedness

Connectedness is achieved by developing a logical network of streets and open spaces that allow pedestrians to easily access the coastal edge and neighbourhood services. Connected networks maximise recreational use and enjoyment of the entire peninsula, and provide for functional ecological corridors across the peninsula and around the coastal edge.

The landscaping of front yards contributes to the continuity of planting themes in character areas.

Connectedness with the past (i.e. the former use of the site as an airbase) is achieved through preservation, enhancement, interpretation and design reference to historical features. Heritage landscapes and buildings will be embedded into the character of the development, and should be referenced in the design of streets and parks

Greenness

The quality of the landscape and an overall impression of greenness created by street tree planting and front yard landscaping will result in an overall consistency and character for each neighbourhood.

The landscaping of private front yards can be used to supplement the street tree and public realm planting, while clearly differentiating private and public space. (Refer to Street and Lot Frontage Planting Themes Plan and associated explanation on the following page).

Setting

Setting overlaps both 'connectedness' and 'greenness'. In Landscape it is honoured and reflected particularly through vegetation species selection, the configuration of the site whether public or private and fence/wall heights. Designs should take into account their context in relation to cultural and social features (including buildings and spaces of heritage value) alongside their landscape context including topography, the coastal edge etc.

Plant selection, in particular tree selection should be considered carefully to ensure appropriate species are used in the right location. Character zone, size, sightlines, views and solar aspect, growing conditions and leaf drop should all be taken into account.

1.4 LANDSCAPE



0 50 100 150

LEGEND

- Precinct Boundary
- Indicative Block Boundary
- Coastal Edge
- Urban Boulevard
- Park / Greenway

1.4.2 STREET AND LOT FRONTAGE PLANTING THEMES



STREET AND LOT FRONTAGE PLANTING THEMES- EXPLANATION

Coastal edge

- Tree and plant species in this zone should be native coastal species.
- Trees with native bird attracting properties should be given preference over those without.
- Species should be ecologically appropriate for use in Auckland's upper harbour



Park / Greenway

- Fronts of lots should be hedged
- Street and park trees should include native bird attracting species e.g. *Vitex lucens*, *puriri*
- Native species should be considered a priority but exotic species may be used.
- Shrub planting should be 'lush' and 'glossy green' in character and should include shrubs with large glabrous, leaves
- Alpine or desert species are not acceptable
- More traditional flowering shrub or hedge species such as *Camellia* spp. are appropriate in this theme provided they are green and lush in their aesthetic.
- Trees in front yards should include fruit trees where possible

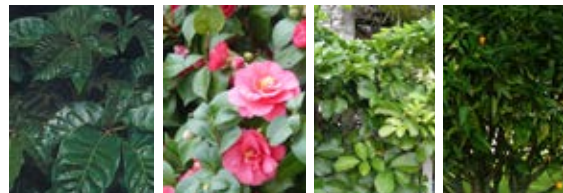

Urban boulevard

- Large scale deciduous street trees: *Liriodendron tulipifera*
- Planted berms to contain robust shrub species with architectural form e.g. *Phormium* spp
- The large pohutukawa tree on Hobsonville Point Road should be retained in its current position, gardens (including front of lots) adjacent this tree are to have native coastal shrub planting to create a feature node of coastal character in street



Notes

- Refer: *Native to the West, A guide for planting and restoring the nature of Waitakere City* for guidance on selection of appropriate native species.
- Where native species are used, eco-sourced plants (grown from local seed) should be used wherever possible to maximise ecological outcomes.

1.4 LANDSCAPE

1.4.3 DESIGN FOR COMMUNITY

The following design principles relate to the way in which the consistency and legibility of the public realm contributes to the character and urban form of Hobsonville, and includes:

- streets
- the coastal edge
- neighbourhood open space
- heritage landscapes

Streets

The urban form for Hobsonville Peninsula is 'street based'. This means that the concentration of density, energy and activity is focussed along key avenues or urban boulevards, with priority given to Hobsonville Point Road. Therefore, attention to the quality and detail of these streets is critical to achieve the landscape characteristics of connectedness and greenness, and to reinforce the distinctive character intended for specific streets.

The following principles apply for street planting:

- Where relevant, street trees should be selected to achieve the effect intended by the Street and Lot Frontage Planting Themes Plan.
- At maturity, trees should reach a scale that is appropriate for the width and proportion of the street, and the height of the building frontage to the street.

- The number of tree species used in any street should be limited to achieve continuity and a discernible character for that street. Streets are to have one species of street tree unless otherwise specified by the Street and Lot Frontage Planting Themes Plan.
- Street gardens (e.g. planted berms where indented carparking occurs) are to have one species of shrub consistent for the length of the street.
- Growing conditions (including the size of the tree pit) should be optimised for all street trees to ensure successful establishment and growth.
- The spacing of trees should be minimised to achieve an avenue effect contributing to a high amenity urban environment. This should result in at least one tree per street garden (i.e. where indented carparking occurs).



Example of minor street under construction (Buckley Precinct)



Street trees and street gardens as consistent species.

Coastal Edge Streets

Coastal edge streets require individual and specific design at the time of development to ensure their functional performance is consistent with the development occurring around them, while also allowing access to the coastal edge and coastal walkway for both residents and visitors.

- They should include special carriageway treatment (raised and/or flush) in the form of material and finish, to encourage pedestrian crossings.
- They may also be flush with the coastal walkway for portions.
- Permeable surface materials and Low Impact Design [LID] treatment should be used in these areas where possible.
- Views to the harbour that are opened through vegetation removal must be maintained.
- Any street trees should be native coastal species, in particular pohutukawa.

Coastal Edge Streets: Bomb Point Interface

The street between the apartment zoned land and Bomb Point Reserve requires a high level of individual and specific design .

In addition to the guidelines outlined for coastal edge streets, it should also:

- Be at a level higher than the landscape to allow outlook over Bomb Point.
- Incorporate a footpath only on the inside edge so as to promote the development and use of a pedestrian promenade set into the bank between it and the main body of Bomb Point.

Park / Greenway Streets

The Park/Greenway streets

The Park/Greenway helps create a 'green core' to the Catalina Precinct with a community and pedestrian focus.

- Neighbourhood open space should be located on a Park/ Greenway street
- It should be depicted by way of signage, a change in pavement treatment and or street furnishings, in addition to the asymmetrical street design.
- Raised crossings or special carriage treatment should be provided for pedestrians on the Park/Greenway street, wherever it crosses another street typology.
- Permeable surface materials and Low Impact Design [LID] treatment should be used in these areas where possible.
- Street trees and planting shall be in accordance with the Street and Lot Frontage Planting Theme

1.4 LANDSCAPE

1.4.3 DESIGN FOR COMMUNITY continued

The coastal edge

The continuous vegetated character of the harbour edge is critical to the character of the peninsula, and the integrity of its ecological functions. In addition the following design principles apply:

- An ongoing programme of weed removal and supplementary revegetation planting should be implemented.
- Outlook to the harbour should be provided where feasible along the coastal walkway.
- Plant species should be selected to achieve the effect intended by the Street and Lot Frontage Planting Themes Plan.
- Multiple entry and exit points should be provided to the coastal walkway.
- Passive surveillance (overlooking provided by adjoining houses and streets) should be provided for the coastal walkway where possible, without detracting from the natural experience. Where possible, a minimum of 2m either side of the walkway should be kept open (e.g. no, or only low vegetation present) to provide for passive surveillance and visibility. Alternate walking routes may be provided to access any special features along the walkway.
- Lighting should not be provided for the coastal walkway except in circumstances where there is already partial ambient lighting from adjoining streets, or where full lighting is required for pedestrian safety. A clear entry and exit point exists for this section of walkway.
- Open spaces on headlands should be landscaped to include picnic spaces and allow views of the harbour, the coastal walkway and native coastal vegetation, with some open areas of lawn to allow passive and informal recreation activities.
- Where possible there should be a small carpark at the end of each road adjoining a headland open space to allow access to the coastal walkway for visitors transporting children, bicycles, elderly people etc.
- Seating should be located along the coastal walkway to take advantage of sun and shade, and should include a range of seating options for all ages and abilities, including benches and seats with backs and arms. These should be located with appropriate surrounding space so as not to impede walkway activity when in use.
- The coastal walkway should have its own suite of park furniture and signage, different from that of neighbourhood open space and standardised across all coastal reserves, unless incorporated into low walls and other features that are specific to the design of a space.



Neighbourhood open space

The open space network shall be a connected series of spaces which together perform a variety of functions, including providing for:

- active and passive recreation,
- pedestrian access to the coastal edge
- community and public gatherings
- community groups (i.e. community building)
- amenity for intensive urban areas
- stormwater collection and treatment
- the preservation of heritage features and significant existing vegetation
- ecological linkages

Neighbourhood open spaces are those which cater for the immediate local area and are within an easy 5 minute walking distance of surrounding houses. This excludes the harbour edge, and heritage landscapes. The following general design principles apply to neighbourhood open space:

- Large existing trees in healthy condition should be incorporated for their character, scale and shade value where possible
- New trees should be planted to achieve character, scale and shade, and may be used as a landscape structuring device e.g. to denote entrances, frame views etc.



Planting contributing to ecological linkages.



Play spaces for a range of ages.



Incorporate large existing trees.

- Open lawn areas designed for informal ball sports should be of an appropriate size and proportion, and adequately drained to ensure suitability for the intended level of use.
- Seating should be located to provide options for sun and shade and should include a range of seating options for all ages and abilities such as benches and seats with backs and arms.
- Footpath access should be provided along desire lines, providing logical connections between park features, road crossings and other local services, and should be of a width and surface material that is appropriate for its intended use.
- Universal access should be provided on sloping sites (i.e. where there are steps into a park, an alternate ramped access must also be provided).
- Hard spaces (other than footpaths) should only be incorporated for a specific function (such as ball courts, skate areas, plaza space located on Hobsonville Point Road etc), and should be rationalised across the open space network so that provision is justified in specific locations.
- Perimeter fencing and bollards should be limited in use, particularly where other design features such as planting or earth contouring may be used to deter vehicles.
- All planting when mature and fully maintained (e.g. hedges), should maintain sightlines into and out of open spaces for passive surveillance.
- Any play spaces should be located near other community facilities where possible, and designed to cater for a range of age groups and abilities, and incorporate shade, seating and containment for junior play equipment.
- Areas of planting should be designed to contribute to ecological linkages or neighbouring heritage landscapes where applicable.
- Park furniture should be standardised across neighbourhood open spaces, unless incorporated into low walls and other features that are specific to the design of a space.
- Lighting may be provided along main pedestrian routes and where partial ambient light from adjoining streets may create CPTED issues. Feature lighting may be incorporated into plaza spaces or used to highlight special park features.

Heritage landscapes

The design and management of Bomb Point will be subject to a specific landscape and heritage management plan. It must respect and reflect the heritage character of the landscape and built features within it.

1.4 LANDSCAPE

1.4.4 DESIGN FOR LIVING

Detached housing typologies

Detached housing typologies typically have a greater setback between the building frontage and the street than attached housing typologies or apartments. Building setbacks are also likely to be greater on north facing sections, to allow for private outdoor living space.

A front yard is the realm between public and private and shares elements of both, i.e:

Semi-public: Front yards overlook the street and contribute to a sense of community and being neighbourly. Tree planting in front yards helps to reinforce an overall impression of greenness and consistency relating to the character and scale of street tree planting.

Semi-private: Front yards are an extension of the house and reflect the lifestyle of the people living there. Front yards are personalised by planting, and reflect a keen interest in gardening and outdoor living.

The following design principles apply to the front yards of detached housing (i.e. private yards that are visible from the public realm):

- Where fences and walls are used to demarcate front yard boundaries, the height and location of these elements must provide a degree of privacy while still allowing outlook and surveillance of the street. The distinction can be assisted with planting, changes of level and surface material.

- Corner lots require special treatment. Where a lot has two frontages they should both positively address the street. In these situations the front yard treatment should extend around the corner for at least the same distance as the lot width. Semi-transparent fencing and screen planting must be used for the rear yard.
- North facing front yards should accommodate private outdoor living areas that do not necessitate high fences on the front boundary, including corner sites. This can be achieved with planting and/or pergolas, partially enclosed decks and verandahs, changes in levels, or other architectural structures set back from the street and associated with the house.

Further detail on private outdoor living is provided in the Architecture section of this document.



Low fence on corner lot extends around corner.

Attached housing typologies

Attached housing typologies typically have a small front yard that is predominantly planted, and may include a change in level, and/or a low wall or fence to demarcate the front yard boundary and create a distinction between public and private space. As with the detached housing, building setbacks are likely to be greater on north facing sections, to allow for private outdoor living space.

For attached dwellings, particular attention is required to address privacy, overlooking, connection to a living area, and sunlight access to private outdoor living areas. This is covered in more detail under 1.3 Architecture.

The following design principles apply to the front yards of attached housing (i.e. private yards that are visible from the public realm):

- Front yard landscaping may provide some coherence to a block of attached dwellings, with repetition of some elements. However the individuality of each unit should also be expressed in the design of each yard.
- Corner lots require special treatment where a lot has two frontages that must positively address the street. In these situations the front yard treatment should extend around the corner for at least the same distance as the lot width. Semi-transparent fencing and screen planting should be used for the rear yard.
- Where possible, north facing front yards should have architecturally designed solutions for private outdoor living that are integrated parts of the building, such as a raised terrace or front verandah.



Front yard landscaping provides coherence along block.



Smaller front yard planted to boundary.

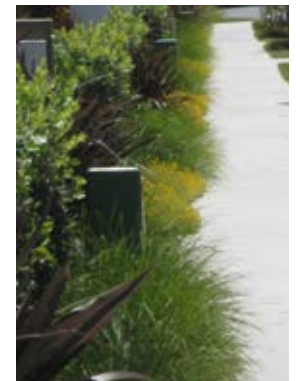

1.4 LANDSCAPE

1.4.4 DESIGN FOR LIVING continued

Apartments and communal open space

Apartment open space and landscaping should improve the overall living environment for residents, and enhance the amenity of the development for both residents and the public. Open space may be private, public, or communal, and a clear distinction should be made between each of the different types of ownership.

Private open space may be provided in the form of a balcony, deck, terrace, ground level courtyard garden, or roof terrace. For the private open space of apartments, particular attention is required to protect privacy, minimise overlooking and overshadowing, and optimise sunlight access. This is covered in more detail under 1.3 Architecture.

Where open space is visible (and possibly accessible) from the public realm it should help to integrate the development into the surrounding area. The following design principles apply:

- Where an apartment frontage is set back from the front boundary, landscaping should contribute positively to the overall coherence and character of the street.
- Where the building frontage incorporates separate entrances to ground floor units, these entrances should be individually defined by landscaping.
- Good connections, layout, and internal way finding should be provided
- Good passive surveillance should be provided
- An appropriate balance of both hard and soft landscaping should be provided, incorporating trees that are of an appropriate scale in relation to the building, and providing an attractive outlook for residents.
- Seating, shade and lighting should be provided as a minimum.
- An outdoor children's play area may be required as part of a communal space, depending on the size of the apartment development and the proximity of public open space with play equipment.

Communal open spaces are shared by residents and allow community identity to develop. In addition to the design principles for communal open space covered under 1.3 Architecture, the following design principles apply for landscaping:

- The size and proportion of the communal open space should be proportionate to the scale of the building, and configured to be usable and accessible for all ages.



Passive surveillance



Seating and shade



1.4.5 DESIGN FOR QUALITY

The character and amenity of a street or neighbourhood is affected by the quality of planting and hard landscaping in both the public and private realm. Each street should have a coherent spatial composition and use consistently high quality plants, materials, finishes and construction methods. Front yards also introduce variety, personality, visual richness and texture to the street through planting, fencing and paving.

The quality of open space, both public and private, is critical for neighbourhood amenity, image and liveability. All landscape elements should:

- reinforce the character of the street or open space,
- provide coherence as well as variety and interest,
- contribute to the connectedness and greenness of the neighbourhood.

The design principles for public areas, i.e. streets and open spaces, are included under Design for Community. The following design principles apply as a benchmark for the quality of private front yards where visible from the street.

Trees

- At maturity, trees should reach a scale that is appropriate for the width and proportion of the street and the height of the building frontage to the street.
- The selected tree species should be appropriate for the character of the street, e.g. where existing trees influence character, or to complement a chosen street tree theme.
- Where applicable, tree species should be in keeping with the Street and Lot Frontage Planting Themes Plan in this document.
- Trees planted in front yards should be accommodated inside the front boundary where the setback clearance between the front wall / fence and the building is 2m or greater in distance. Care should be taken not to plant trees in conflict with buildings or other structures, or hedges.
- Trees planted in front yards should be a minimum size of Pb 150 (exceptions may be considered subject to availability for particular species such as fruit trees)
- Trees are best integrated within the front yard planting, with shrubs or groundcovers at their base so as not to compromise usable lawn space on lots with larger setbacks.
- If Nikau or Cabbage trees are chosen as front yard trees, these would be planted in groups, with multiple trees per lot where possible.
- Streets are to have up to three species of trees in front yards.
- Trees in front yards in a non themed area may include fruit trees where practical



Coherence and variety in streetscape



Evergreen trees in front yards compliment deciduous street trees



Trees to be located inside front boundary fence and/or hedge with shrub planting at base.



Nikau in group of three

1.4 LANDSCAPE

1.4.5 DESIGN FOR QUALITY continued.

Front yard planting

Front yard planting must define front boundaries, reinforce entrances, soften hard surfaces, screen services, and provide privacy and separation between each lot. Where front yards are being actively used as private living spaces such as courtyards for seating and eating, designs should enable the creation of spaces that help reinforce these activities. E.g. through incorporating raised courtyards, simple hedges up to 1.2m and deeper shrub planting beds that help create a feeling of privacy without unduly screening the area completely from view.

Planting should be designed to create layers of height, texture and colour.

All front yards with a setback of less than 3.5m should be entirely planted (as opposed to lawn) where soft landscaping is required.

Where applicable, plant species should be in keeping with the Street and Lot Frontage Planting Themes Plan in this document.

All front yard planting (excluding trees) must be:

- limited in overall height to maintain outlook to the street
- mass planted to achieve a continuous and even coverage once mature.
- a minimum grade of PB12 for hedges and screen planting, and min Pb5 elsewhere
- a single species used for hedges
- selected and sited for optimum growing conditions (e.g. for shade /shelter)
- appropriately selected for intended purpose (e.g. larger shrubs for screening)

Fences and walls

Fences and walls on the front boundary should not be more than 900mm in height, with the exception of heritage buildings and their yards where fences may be up to 1500mm in height.

All lots should have a front fence or low wall combined with planting on the boundary line, except in the following circumstances:

- Where the building is within 1.5m of the front boundary and separation is created by planting or other architectural elements (e.g. steps, terrace, verandah).
- At the front yard interface with the Coastal Edge character area where the Coastal Edge boundary setback is 5m or greater.



Layers of height, texture and colour.



Outlook to street maintained.



Hedges of consistent species.



Setbacks less than 3.5m are entirely planted.

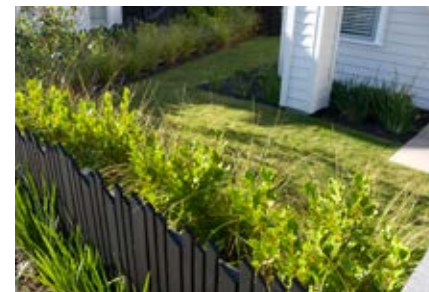

Setbacks more than 3.5m can include lawn.

When designing the style of front yard fencing, care should be taken to avoid:

- long stretches of the same fencing type along a street,
- a different type on every lot, or
- predictable and repeated patterns of fencing types.

Front yard fencing should be designed to:

- be in keeping with the architectural character of the house without needing to match it in appearance, colour or materials,
- achieve an appearance of substance and depth, using high quality detailing, construction and materials (i.e. not sheet panels)

Service plinths may be integrated with, recessed within, or placed behind the front fence so that they are not prominent in view. Where a fence or wall is set back from the front boundary (typically by 0.6m) to allow for a service plinth, planting should be incorporated in front of the wall to assist with screening.

Where a 1.8m high privacy fence is visible from the public realm (e.g. corner lots and rear lanes), the top 0.5m portion of the fence should be semi-transparent.

Coastal Edge and Public Open Space Fencing

Where a boundary is shared with an open space, fences and or walls are encouraged to be not more than 900mm high regardless of front, side or rear boundary situation. Where this is not practical, a higher fence may be constructed provided it is visually permeable. Fences and walls on a boundary shared with an open space or the coastal edge should not be higher than 1.5m and should be permeable when higher than 1.2 (refer definition diagram in Technical Annexures).

- Fencing should be treated similarly to street front fencing in design and materials.
- Lots interfacing with the coastal edge character area should reinforce it by extending planting themes into front yards to maintain a natural and informal interface, and should,
- use low planting to allow passive surveillance of the walkway,
- have a similar or complementary theme to the adjoining coastal edge or public open space planting.



Service covers located in 600mm strip in front of fence, planting to screen.



Example of low wall on Buckley Ave.



Examples of low fences with good level of detailing.



Privacy fence with permeable top.

1.4 LANDSCAPE

1.4.5 DESIGN FOR QUALITY continued.

Gates

- Gates may be incorporated into fences and walls for pedestrian entrance paths or across driveways. The gate should be in keeping with the scale of the fence or wall with which it is associated, and should be permeable (semi-transparent).
- Gates to back yards visible from the street should appear seamless with privacy fences separating front and back yards.
- Where a property is located on a boundary with public open space, for example the coastal edge, a gate may be located within the boundary fence allowing access from the yard. This gate should appear seamless with the fence.

Retaining walls

- Timber pole retaining walls to the front yards should be planted, or screened from view. Treated pine walls should be stained or painted black.

Letterboxes

- Each house or attached unit should have an individual letterbox, with the exception of apartment blocks which may have grouped postal boxes. Letterboxes must be located on the front boundary and accessible from the path or driveway providing access to the front door.
- Letterboxes should be fit for purpose and functional, and designed with balanced proportions and robust, quality materials. House numbers should be clearly visible from the street.
- Letterboxes should be integrated with a blade wall or fence.



Gates to back yards incorporated in privacy fences.

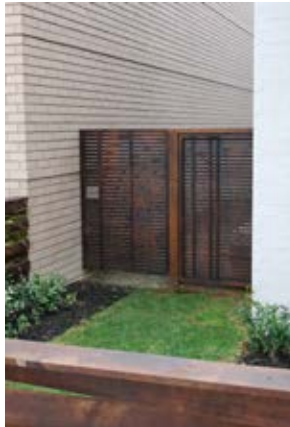

Concrete block retaining wall to front boundary with planting to screen.



Examples of letterboxes incorporated into walls.



Driveways

- The material should be concrete paving or a similar material with a high quality finish and sawcut pattern. Black oxide should be added to the concrete mix to soften its appearance when constructed.

Entrance paths

- Paths should be provided for each house or unit and should be connected to the footpath in the adjacent street or park. Steps, terraces or other architectural features may replace paths where there is a reduced setback and where a change in level is created.
- The path width should be appropriate for the building type and its intended use i.e. the path width may be wider for an apartment building than for a townhouse.
- The material and finish may vary, however a durable paved surface should be used (as opposed to loose material).

Signage

- All signs should be visually appropriate to the amenity and heritage values and neighbourhood character of the surrounding environment.
- Signs should avoid creating any situation hazardous to the safe movement of traffic.
- Signs should avoid dominating the neighbourhood and nearby structures.
- Sensitive design is required for any signage associated with existing heritage buildings and places.



Driveway width = garage door width.



Examples of suitable entrance paths.



1.5 BIODIVERSITY MANAGEMENT

The retention and enhancement of the existing coastal and stream network is key. Development should seek to enhance the biodiversity of the site by creating an enhanced ecological environment where rare or threatened species can exist or obtain passage through, while at the same time providing an attractive environment for communities to recreate through active and on-going participation.

The management of biodiversity will be addressed at subsequent resource consenting stages for physical works within the application site, including future open space areas. This will include a variety of plans/initiatives e.g. a coastal revegetation plan, weed and pest management, general landscaping plans, lizard management plan etc.

Threatened species and habitats are to be enhanced throughout the proposed local reserve network, particularly along the coastal edges and within riparian areas of the site. The development of walkways, infrastructure and associated structures shall be undertaken in a manner that maintains and enhances the biodiversity potential of these environments.

This network of green space should create connections between habitat nodes along existing natural coastal and stream networks allowing for safe passage of wildlife populations. The quality and quantity of stormwater inputs in to the harbour receiving environment will be enhanced. In addition, an integrated network of public open space will provide local communities with the opportunity to explore and enjoy the natural environment.

Any walkways or board walks should be designed to avoid or minimise adverse effects on the plant and animal communities that are present.

Where possible all permanent streams should be retained and enhanced to provide suitable fauna habitat. Where this is not possible, any loss of fresh water habit will need to be mitigated.

There is the presence of a range of notable plants at Hobsonville Point. In addition, there are a number of threatened plant species in the area.

The careful consideration of these species should be an integral part of area specific landscaping/development plans with their retention and enhancement being the key aims.

It is noted that saltmarsh habitats may contain locally uncommon plants. These are important components of the overall biodiversity, and provide the interface between the coastal edge and CMA, and as a result may require site-specific management strategies.

The coastal edge provides important habitats generally to avifauna and there is need for site-specific management in some areas (e.g. predator control adjacent to rushmarsh used by banded rail – as in Catalina Bay).

A lizard survey has been undertaken and this will include the development of a lizard management plan for the site.

The above matters will need to be addressed through the subsequent resource consenting phase for physical works.



2

CATALINA SUB PRECINCT TECHNICAL ANNEXURES

2.1 DEFINITIONS

1. LOCATION OF PRIVATE OUTDOOR SPACE

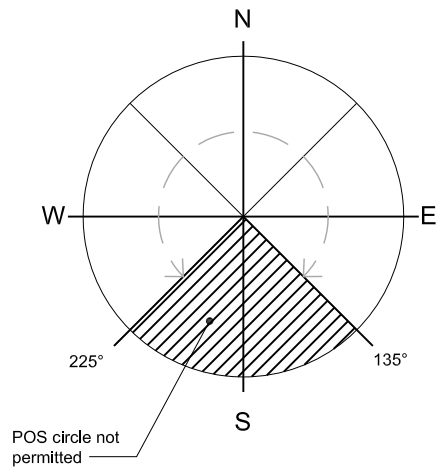

2. FRONT SETBACK

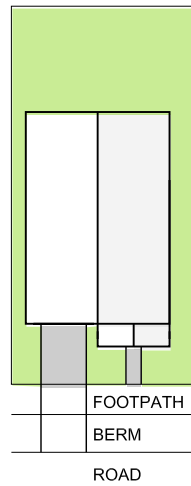

In circumstances where the front face of the building is not parallel with the front boundary, any maximum or minimum front setback dimensions shall apply as the average distance between the face of the building and the boundary.

front setback

3. FRONT YARD LANDSCAPING

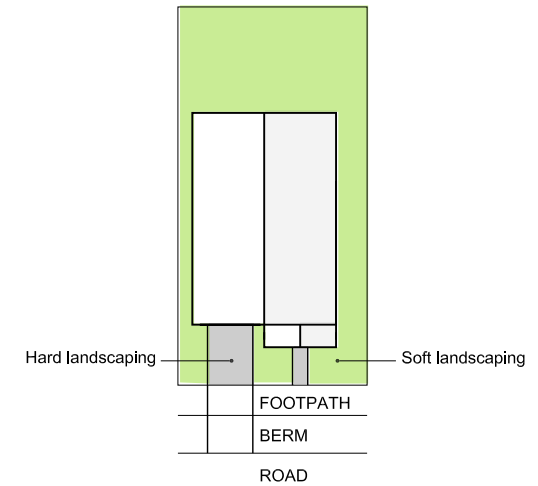

4. GARAGE SETBACK

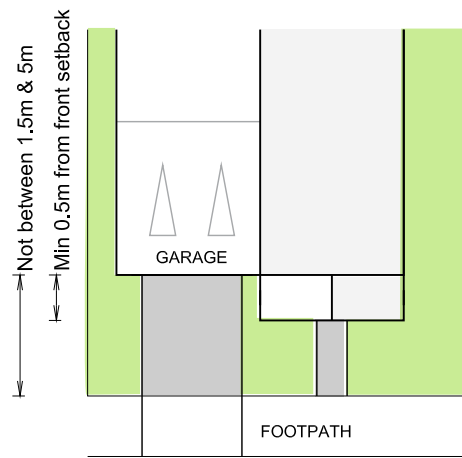

6. DRIVEWAY CROSSINGS

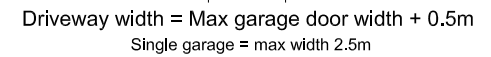
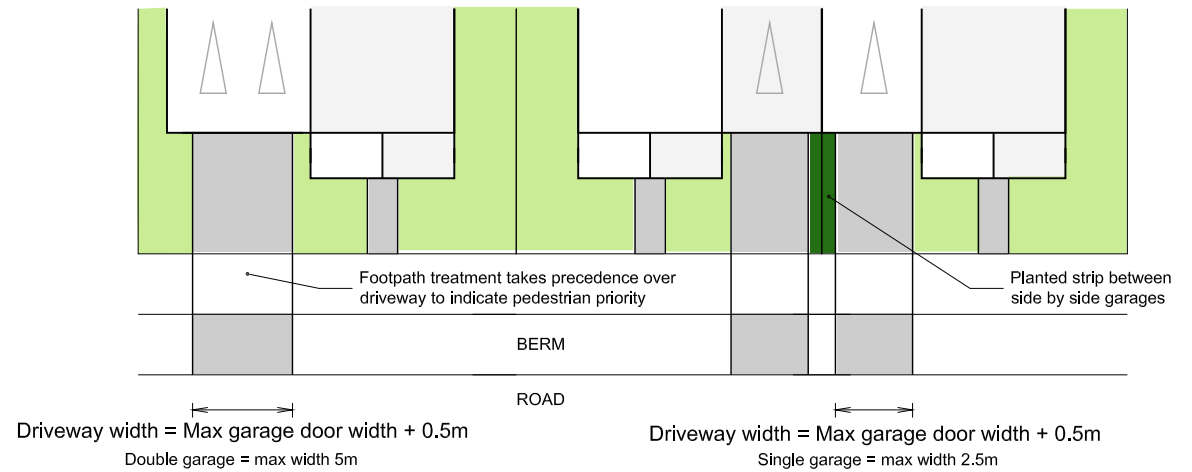

5. OCCUPIED FRONTAGE

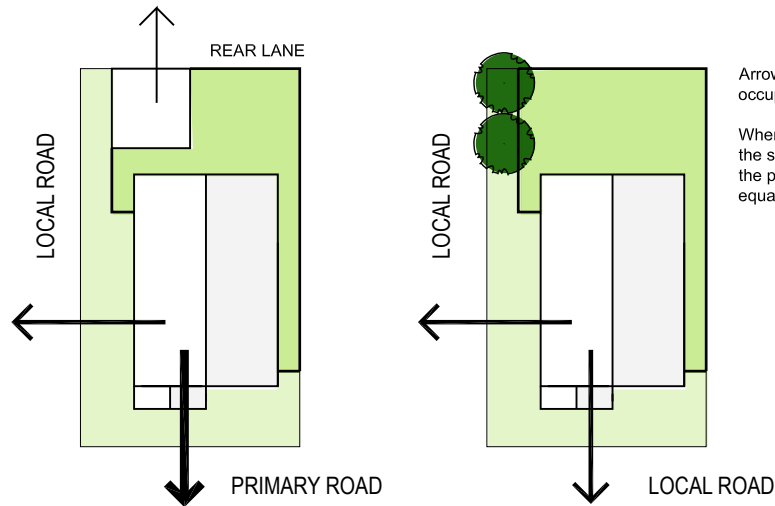

7. CORNER HEIGHT AND SETBACK

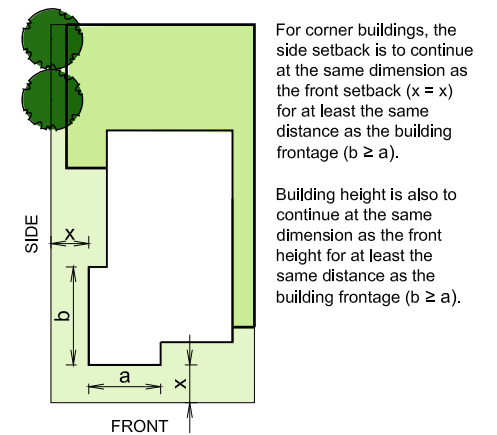

2.1 DEFINITIONS

8. BUILDINGS >4 FLOORS HIGH

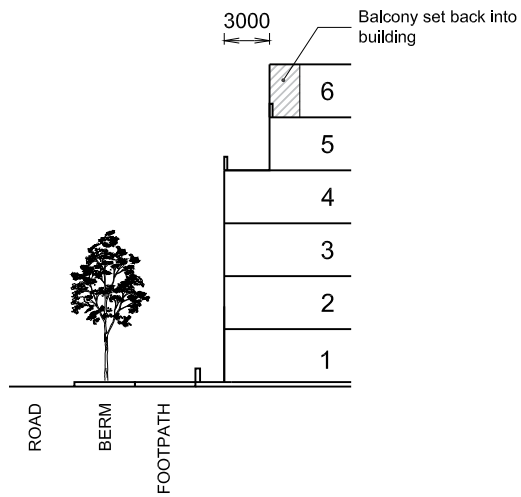

9. FENCING

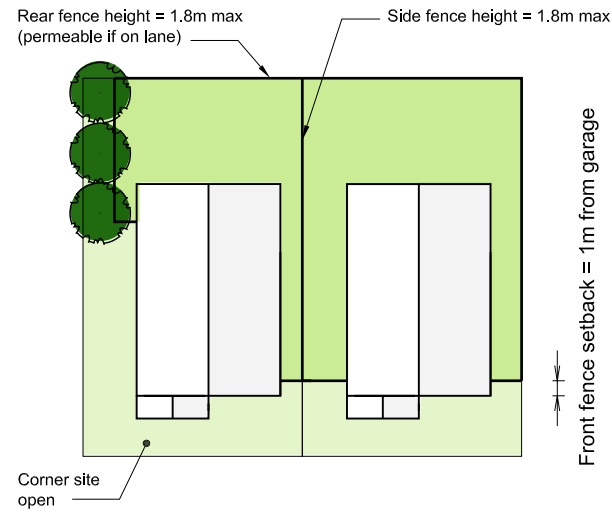

10. FENCING - LOTS ON COASTAL EDGE OR PUBLIC OPEN SPACE BOUNDARY

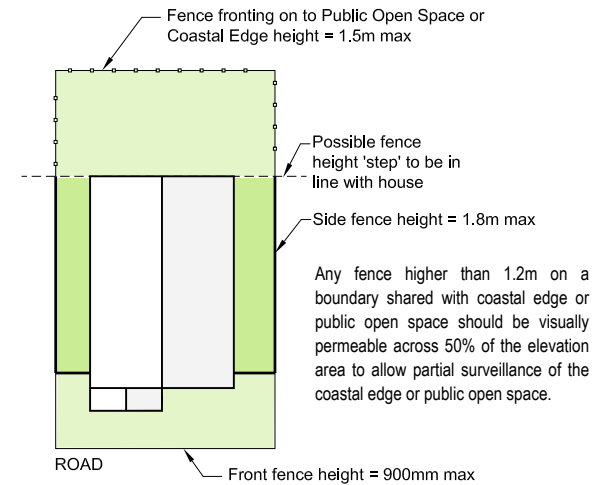

2.2 STREET CROSS SECTIONS

INDICATIVE STREET CROSS SECTION - SECONDARY ROAD

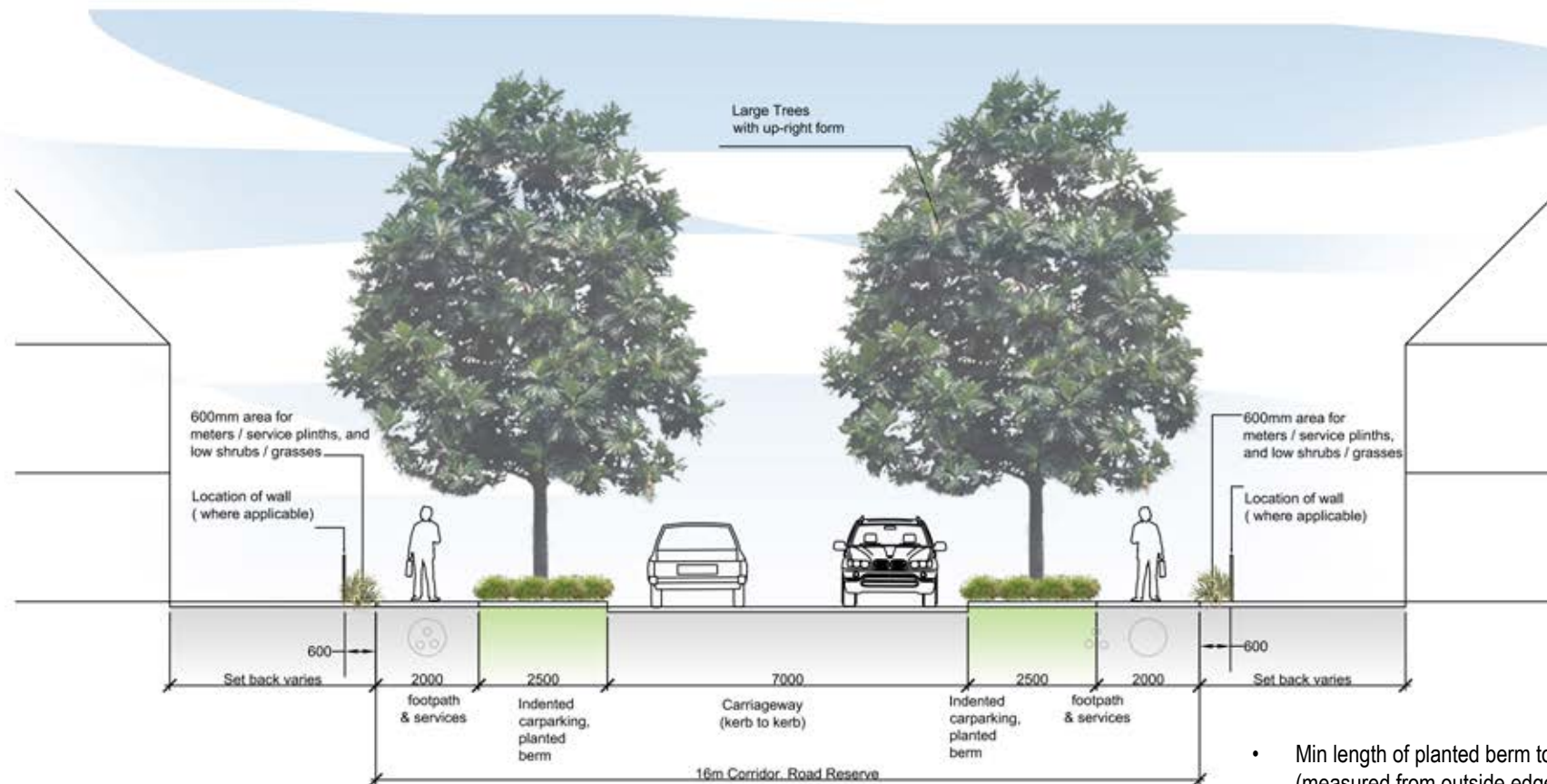

- Min length of planted berm to contain trees: 2.5m (measured from outside edges).
- 600mm area for plinths to be within private property with access by utility companies (no walls to be allowed in front of 600mm area).
- Mountable kerbs to be used for indented carparking.

2.2 STREET CROSS SECTIONS

INDICATIVE STREET CROSS SECTION - SPECIAL CHARACTER LOCAL ROAD

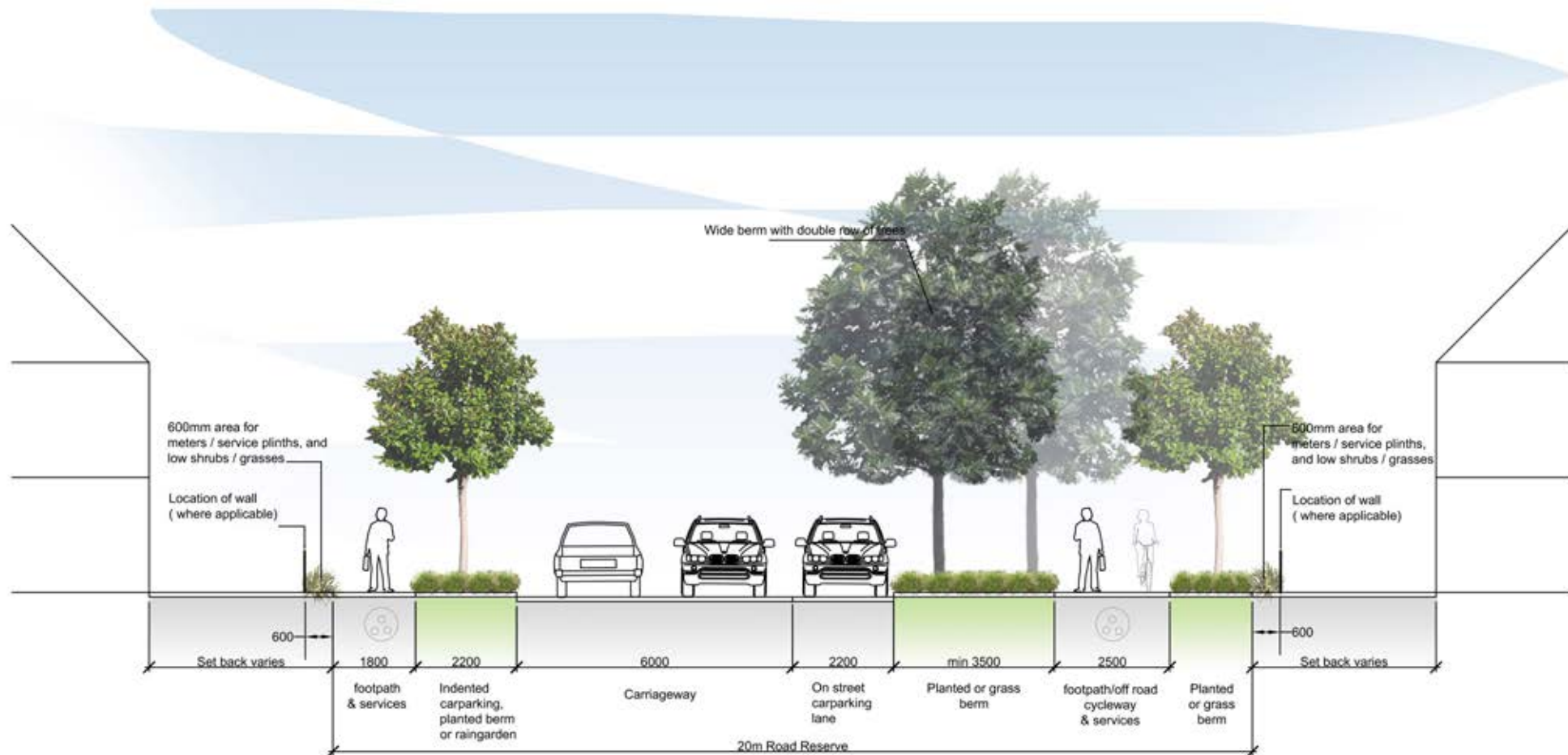

- Min length of planted berm to contain trees: 1.8m (measured from outside edges).
- 600mm area for plinths to be within private property with access by utility companies (no walls to be allowed in front of 600mm area).
- Mountable kerbs to be used for indented carparking.
- Stormwater low impact design devices may be incorporated and carriageway, parking and planting dimensions may be adjusted accordingly.

2.2 STREET CROSS SECTIONS

INDICATIVE STREET CROSS SECTION - LOCAL ROAD

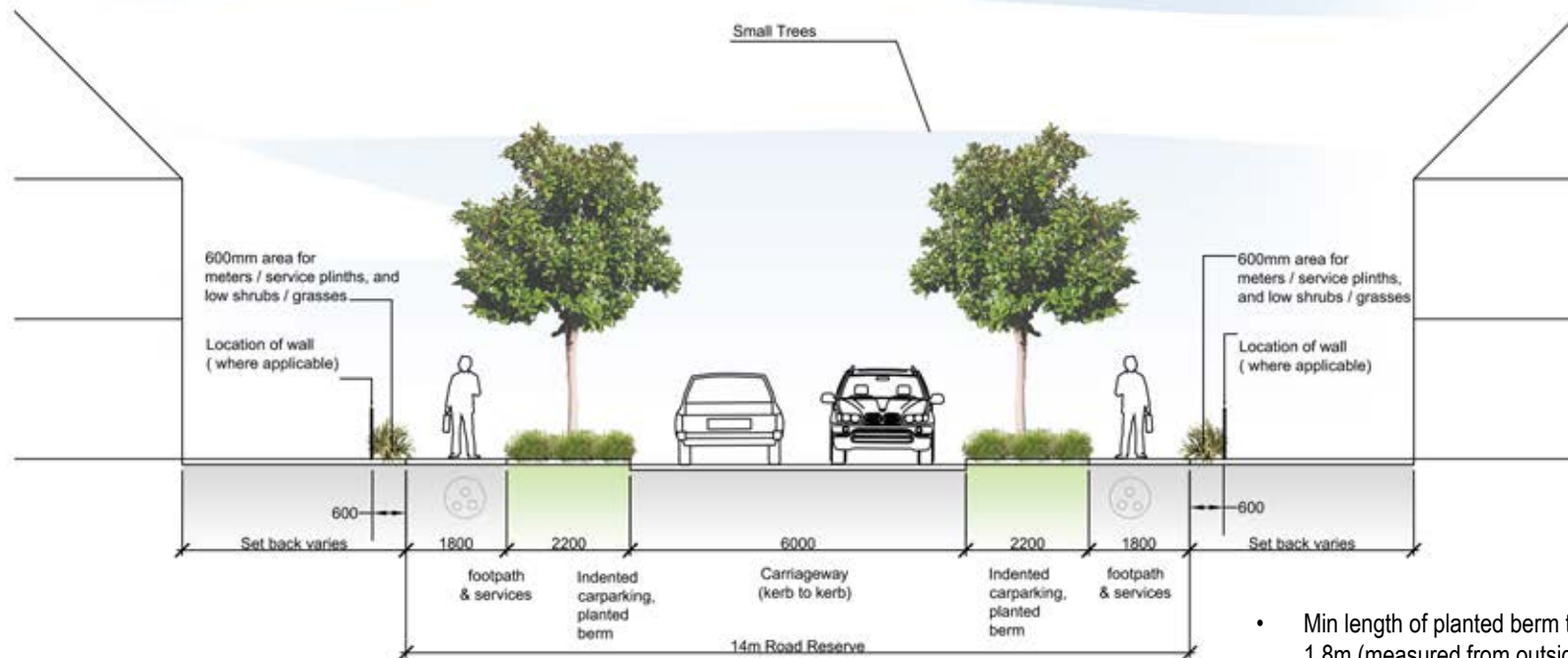

- Min length of planted berm to contain trees: 1.8m (measured from outside edges).
- 600mm area for plinths to be within private property with access by utility companies (no walls to be allowed in front of 600mm area).
- Mountable kerbs to be used for indented carparking.

2.2 STREET CROSS SECTIONS

INDICATIVE STREET CROSS SECTION - COASTAL DRIVE (ADJACENT COASTAL WALKWAY)

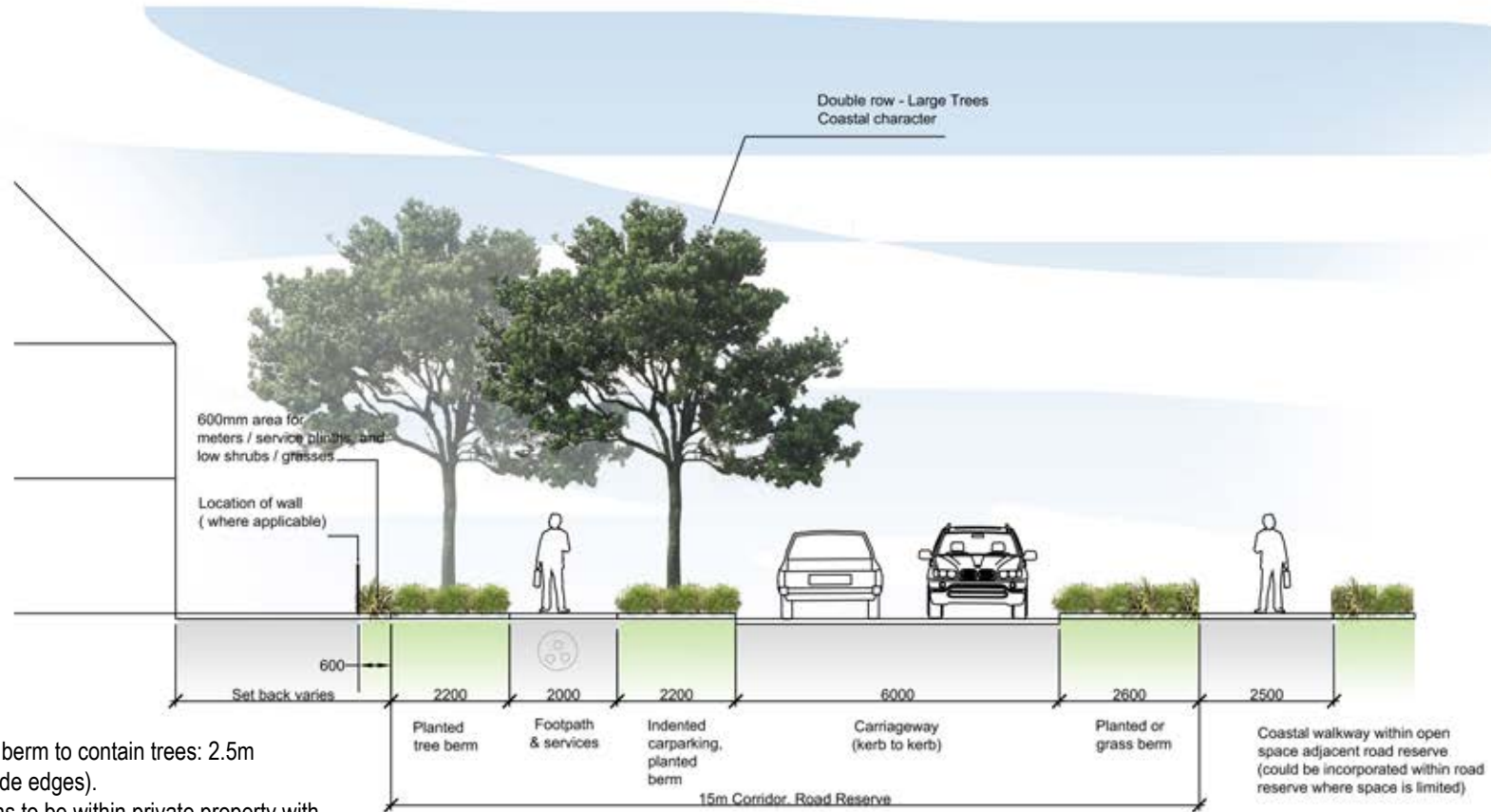

- Min length of planted berm to contain trees: 2.5m (measured from outside edges).
- 600mm area for plinths to be within private property with access by utility companies (no walls to be allowed in front of 600mm area).
- Mountable kerbs to be used for indented carparking.

INDICATIVE STREET CROSS SECTION - COASTAL DRIVE (BETWEEN SUPERLOTS)

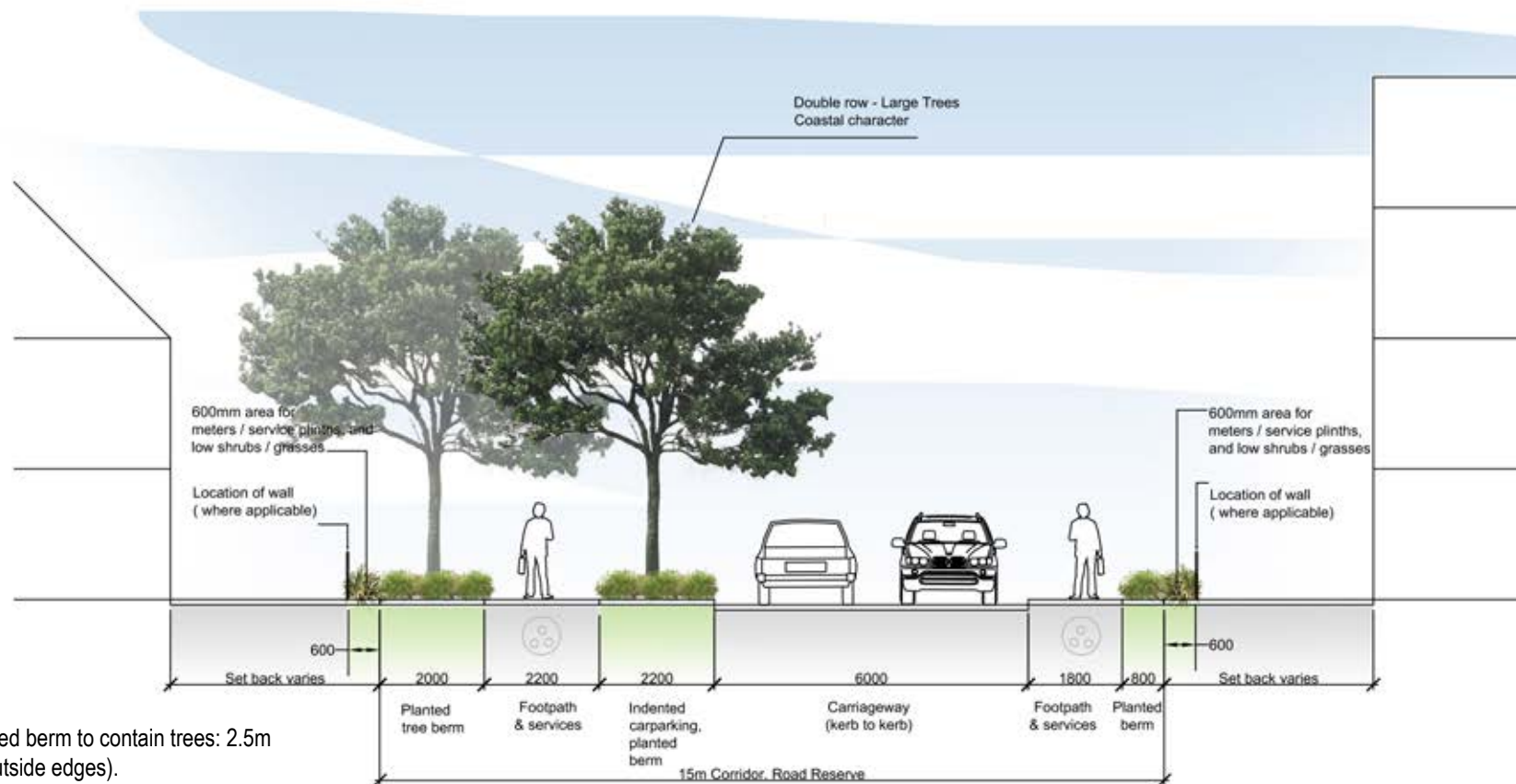

- Min length of planted berm to contain trees: 2.5m (measured from outside edges).
- 600mm area for plinths to be within private property with access by utility companies (no walls to be allowed in front of 600mm area).
- Mountable kerbs to be used for indented carparking.